



Privacy screens A1 and S1 and flower box B1

PRODUCT DESCRIPTION

Our privacy screens feature a sleek, modern aesthetic that complements any outdoor décor. Made from baked-on paint-coated aluminum, they withstand all weather conditions, ensuring long-term durability. A primer is applied before and after painting to optimize the paint's benefits. Maximize your deck space by creating more secluded areas or add intimate shade to your backyard patio. Looks can be tailored to your style with a variety of opening sizes or custom patterns available upon request.

- Easy assembly
- Industrial-grade aluminum
- UV protection
- Rust-free
- Weather-resistant

TECHNICAL PROPERTIES

	Properties	Typical value	Test method
Mechanical	Tensile strength (psi)	9 600	ASTM D638
	Elongation at break (%)	4.5	ASTM D638
	Modulus of elasticity (psi)	425 000	ASTM D798
	Impact resistance (ft lb/in)	0.4-0.5	ASTM 256
	Reflection resistance (psi)	15 000 - 16 000	ASTM D 798
	Rockwell hardness	M95	ASTM 785
	Barcol hardness	50	ASTM 2583
Thermal	Forming temperature (C)	140 - 180	
	Forming temperature (F)	284-356	
	Deflection temperature under load (264 psi) (C)	91	ASTMD 648
	Deflection temperature under load (264 psi) (F)	196	ASTMD 648
	Maximum recommended continuous operating temperature (C)	80	ASTM 1525
	Maximum recommended continuous operating temperature (F)	176	ASTM 1525
Others	Water absorption - 24 hours at 23°C or 73°F (%)	0.30%	ASTM 570

All values refer to an acrylic sheet with a thickness of 3.0 mm (0.118"). These values are typical and should not be considered specifications for all products.

A1

Weight: 26 to 38 lbs

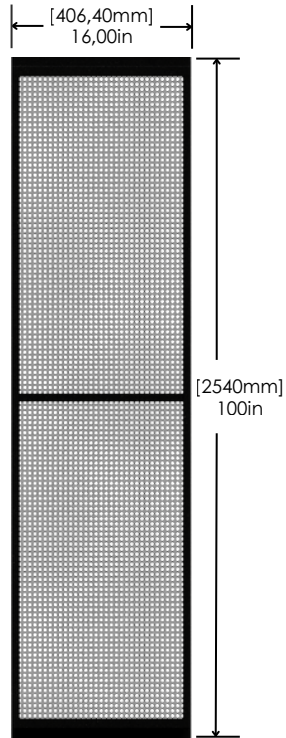

S2

Thickness: 20 Ga
Weight: 39 to 45 lbs

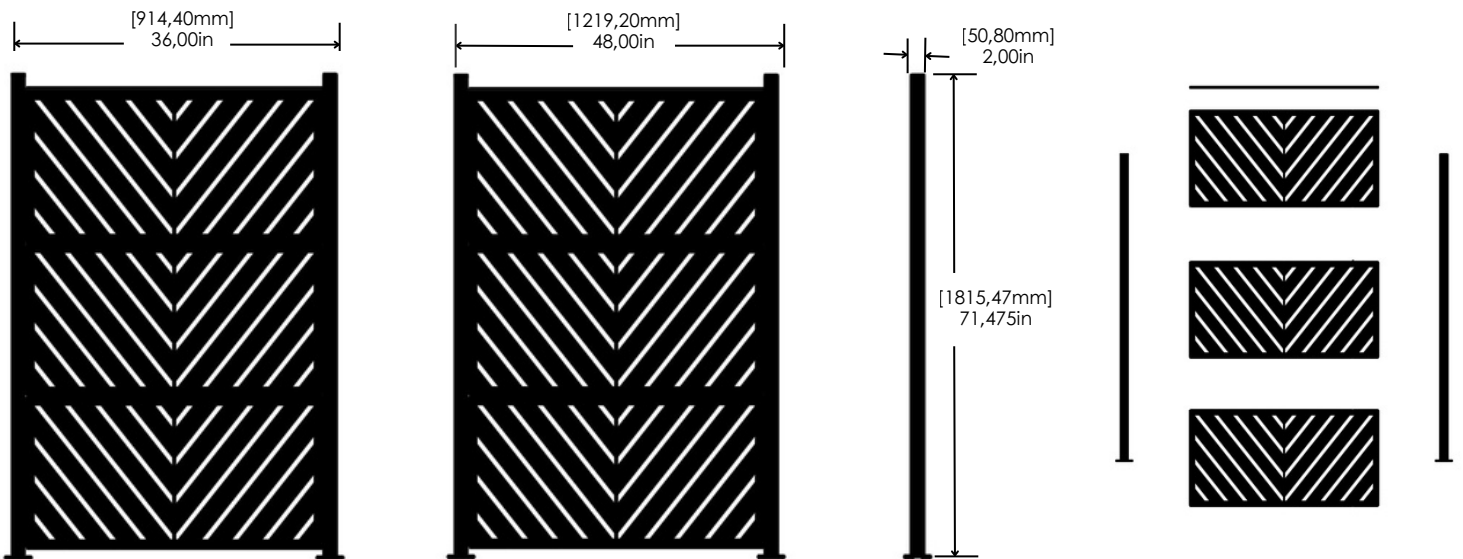

B1

Available sizes: 32 in. and 44 in
Thickness: 20 Ga
Weight: 17.02 lbs

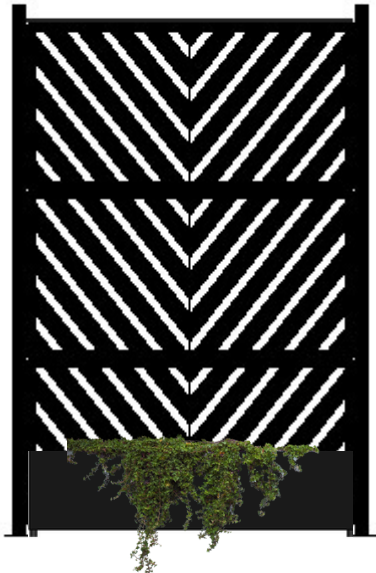
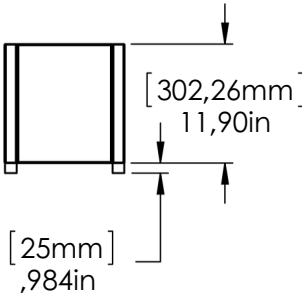
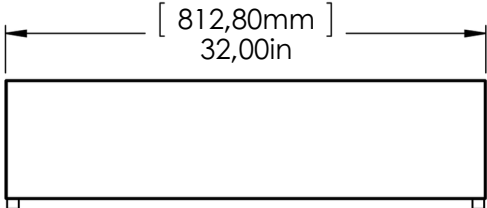
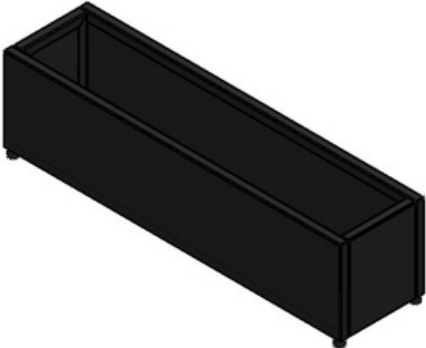
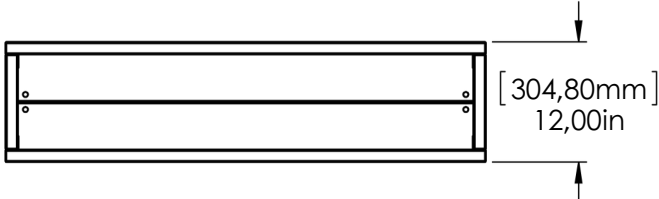

DIFFERENT PATTERNS

Our modular screens offer a world of possibilities. It is possible to reverse the patterns to achieve the desired design.

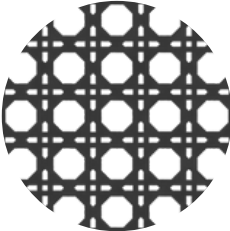

Rattan
60% privacy

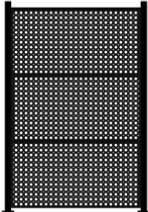

Linear
75% privacy

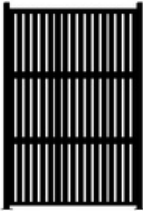

Chevron
75% privacy

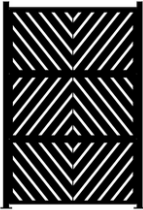

Divergent
62% privacy



HOW TO ORDER

To order a product, please write to info@boreart.ca using the following template to ensure maximum accuracy.

The first two characters are the model code, followed by the pattern code; then come the desired dimensions, and the last letters represent the color.

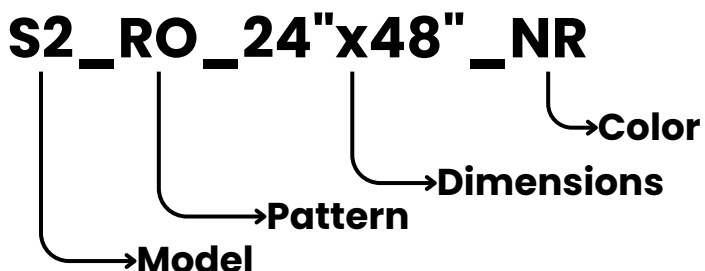

Patterns

Rattan :	RO
Linear :	LI
Chevron :	CH
Divergent :	DI

Colors

Black :	NR
White :	BL

*As they are custom-made, our screens are also available in other colors and sizes to meet more specific needs. For any custom orders, please contact us by email or phone.